

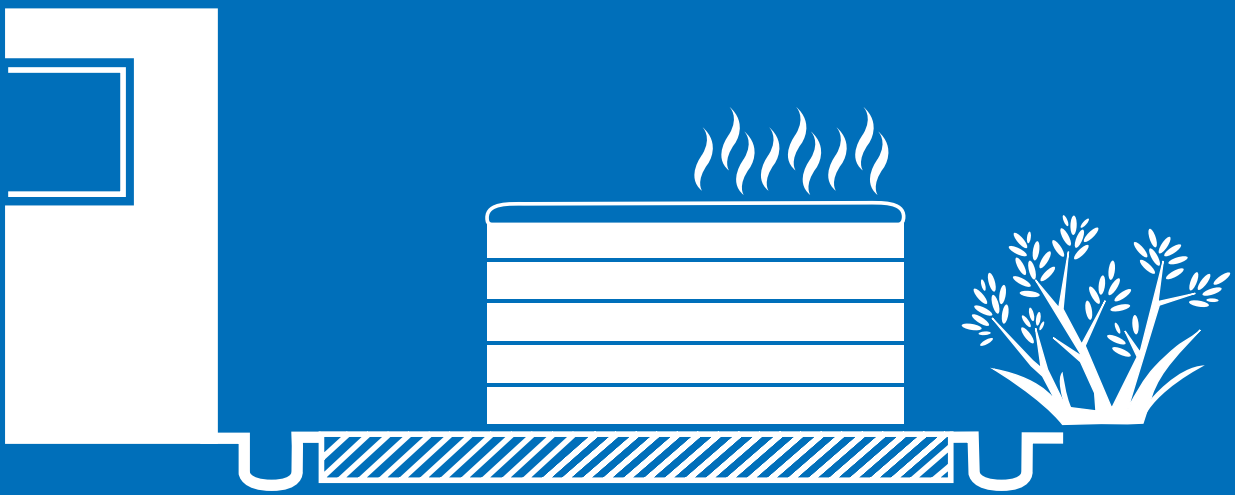

# Spa Pool Pre-Delivery Guide



# Contents

<b>Delivery</b>	1
Overview	1
Delivery Options	2
Setup	2
<b>Choosing an Area</b>	3
Factors to Consider	3
Access	4
Drainage	4
<b>Measurements</b>	5
Spa Pools	5
<b>Positioning</b>	7
Foundation and Base	7
Steps	7
Heat Pump	7
Cover lifters	8
<b>Enclosing the Spa Pool</b>	9
Factors to consider	9
Walls	10
Decking	10
Sinking	10
<b>Electrical Installation</b>	11
Installing a 15A Spa Pool	11
Installing a 25A+ Spa Pool	11
Load Shed	11
Requirements by Model	12
Positioning the Cable	13
<b>Legacy Models</b>	15
<b>Gazebo</b>	16
<b>Notes</b>	17
<b>Sketch</b>	20
<b>Order Checklist</b>	21

# Delivery

## Overview

A Spa Pool delivery is not your basic 'no signature required' courier delivery, it's a delicate and exciting operation. Although these large and heavy objects present some challenges, there's rarely a location we can't get a spa into.

We deliver the most spa pools per year out of any retailer in New Zealand, thousands in fact. You could say we are the spa pool delivery experts.

## Delivery Options

At Alpine Spas we provide you a range of delivery options to suit your needs. Please discuss and confirm all delivery options with your sales consultant.

SERVICE	TYPE	NATIONWIDE	AKL & CHCH	General Installation
<b>Bronze</b>	Collection from Depot	FREE	FREE	Not Included
<b>Silver</b>	Curbside Drop-Off	\$399	FREE	Not Included
<b>Gold</b>	Delivery into Position	\$799*	\$399*	Not Included
<b>Gold Elite</b>	Delivery & Installation	N/A	\$699*	Included

*\*Complex deliveries incur an additional \$200 fee.*

### Bronze - Collection

Your Spa Pool can be collected from our warehouses located in Christchurch, Auckland or from one of our freight providers depots located throughout New Zealand for free. All that is required is a trailer and strops to secure it. Forklift assistance is provided to load the Spa Pool onto your trailer.

*Note: For nationwide depots, allow 3-5 working days from date of dispatch (this is the day the spa pool leaves our warehouse). The depot will get in touch with you when stock arrives.*

### Silver - Curbside Drop-Off

This method has your Spa Pool delivered directly to your property via a transport truck which is contracted to curbside. If access allows and is safe to do so, the driver will attempt to get as far up the driveway as possible. The Spa Pool is removed off the truck with the use of a tailgate and pallet jack and left vertical on a pallet. You will then need to be prepared to move it into final position with manpower or tools of your own. Setup/installation is not included - see 'SETUP' section on the following page.

*Note: Allow 3-5 working days from date of dispatch (day spa pool leaves the warehouse). Transport company will call before delivery. Packaging not taken away.*

## Gold - Delivery into Position

Your Spa Pool will be delivered into the desired final position by use of either a specialised manpower team or HIAB crane-truck (not both). We ask for some clear instructions and sometimes photos to ensure a smooth delivery. For Hiab/Crane deliveries you will need to ensure the accessway is able to withstand the weight of the truck and load. Setup/installation not included - see 'SETUP' section below.

*Note: If extra manpower or crane reach required is over 14 meters (Auckland/Christchurch) or 7 meters (Nationwide), this will be additional, please ask for pricing. Please note: packaging is not taken away.*

## Gold Elite - Delivery & Installation

Your Spa Pool will be delivered into the desired position by use of either a specialised manpower team or HIAB crane-truck (not both). We ask for some clear instructions and sometimes photos to ensure a smooth delivery. For Hiab/Crane deliveries you will need to ensure the accessway is able to withstand the weight of the truck and load. Setup/installation not included - see 'SETUP' section below.

We will unwrap and take away the packaging and pallet. Assemble steps (if included), install cover & cover lifter (if purchased) and install your Heat Pump (if purchased).

## Setup

### Electrical Setup:

Your Spa Pool requires an electrician to install the appropriate required components to get it powered safely. Some models include cable and plug while larger models require cable and hardwiring. We cannot provide this service as we are not licensed electricians but we may have recommendations in your area. Please discuss your electrical requirements with your sales consultant. See page 12 for requirements by model.

### General Installation:

Setting up a Spa Pool is not as complicated as you may first think. It mostly consists of removal of packaging, assembly of accessories and filling with water. The steps (if included) simply piece together in seconds. The cover just needs unwrapping and placing on top of the Spa Pool with the clips then screwed into the side. After you have filled with a hose, pop in the filters. Then as long as you are wired up safely, you are good to go. Take a look at the simple checklist below:

- Remove packaging
- Piece together steps (if included)
- Place cover on spa
- Attach cover clips
- Fill with hose
- Install filters
- Switch on

*Additional accessories such as cover lifters and towel rails will also require installation (basic power tools may be required). Easy instructions are included.*

# Choosing an Area

---

## Factors to Consider

To maximise the enjoyment of your Spa Pool, its location should be carefully thought out. Consider the following points:

- Do you have a view that you wish to look over while relaxing in your Spa Pool? Are there any seats you want facing in a specific direction?
- Is the area sheltered from strong winds?
- Are there potential privacy issues with neighbouring properties?
- What is the distance from the changing area to your spa pool for getting in and out on those colder nights?
- Are there any other features you wish to incorporate to enhance your Spa Pool experience such as decking or a gazebo?
- Does positioning allow easy accessibility to the external drain valve and panels? Carefully read through the access requirements on the following page. Electrical access and requirements may impact location.
- Are you wanting to add decking or lower your spa pool slightly into the ground? See page 10 for details.

## Access

It is the owners responsibility to ensure there is access to your Spa Pool and it's components. See below requirements.

### Electrical Access

The electrical requirements of your Spa Pool may have an impact as to where you choose to position it. A 15A Spa Pool requires a 15A cable (see inclusions page 12) a 15A outdoor socket and RCD to be installed. A 25A+ Spa Pool requires hardwiring of cable back to the switch board accompanied by RCD and isolation switch.

The access of electrical supply to the Spa Pool will need to be considered when choosing an area. See page 11 for more detail regarding electrical requirements.

### Service Access

Your Spa Pool also needs to be positioned so that all of the internal components are easily accessible. Although most of the core equipment (controller, heater etc.) is usually located on the 'front side', access to ALL panels is still a requirement.

Please allow 600mm of clearance around the perimeter of your Spa Pool so that all four sides/cabinets can be accessed. If this is not achievable in your setup, you will need to be prepared to move your Spa Pool into a position where it can be serviced.

## Drainage

Overflow of water from the Spa Pool is likely, especially when overloaded with people or if kids are splashing about. Drainage may need to be considered to prevent water from pooling as flooding issues are not covered by warranty.

We recommend incorporating drainage channels into your foundation to direct water away from the Spa Pool. As an extreme precaution, covered gravel trenches around the perimeter could also be implemented.

Your Spa Pool will need to be manually drained every 3-4 months via an external drain valve to which a hose can attach.

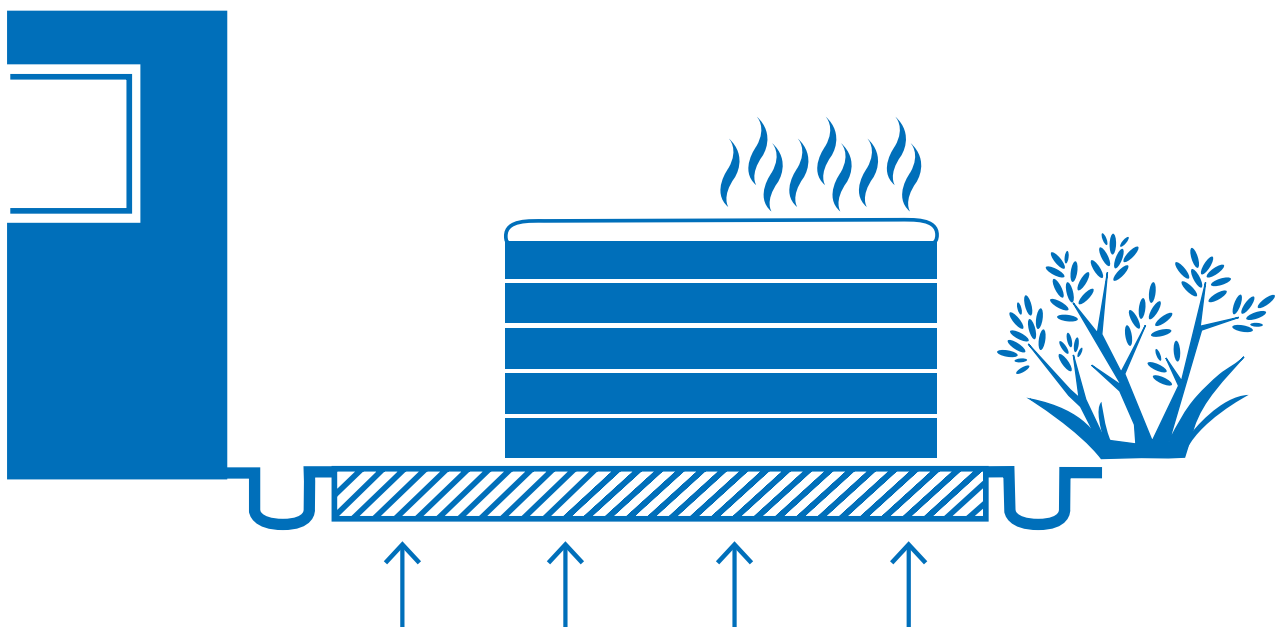

# Measurements

## Spa Pools

Refer to the below table for the unpackaged measurements of your Spa Pool. Use these as a reference when planning your foundation.

For packaged dimensions add 20mm to width & length, and 100mm to the height to account for the wooden pallet.



Model Name	Width (mm)	Length (mm)	Height (mm)	Dry (kg)*	Filled (kg)*
Fuji	2000	1500	760	240	890
Colorado	1990	1990	830	280	1190
Nepal	2000	1500	790	240	865
Utah	2120	1600	850	265	1065
Nordic	1980	1980	830	280	1180
Alaska	1990	1990	830	280	1210
Yukon	2030	2030	900	280	1080
Montana	2000	2000	860	330	1225
Vermont	2010	2010	860	280	1180
Makalu	2130	1600	850	320	1115
Matterhorn	2130	2130	880	380	1380
Lucania	2030		900	300	1280
Sierra	2120	2120	880	360	1610
Vancouver	2190	2190	900	400	1850
Munro	2270	2270	900	400	1725
K2	2270	2270	900	420	1820

ALPINE SPAS

\*Approx weights.

*For Spa Pool Litres, subtract dry weight from filled weight.*





Model Name	Width (mm)	Length (mm)	Height (mm)	Dry (kg)*	Filled (kg)*
Zurich	1650	2130	780	225	1020
Monaco	1900	1900	900	290	1140
Santorini	2000	2000	920	295	1169
San Marino	2100	2100	930	370	1320

\*Approx weights.

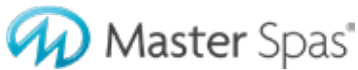

Model Name	Width (mm)	Length (mm)	Height (mm)	Dry (kg)*	Filled (kg)*
San Miguel	1760	2010	820	204	884
Bar Harbor	2210	2210	890	272	1748
Honolulu	2140	2140	920	370	1850
Miami	1990	1990	870	297	1054
Seattle	1990	1990	870	381	1327
Boston	2140	2140	920	420	1631
Grand Canyon	2260	2260	920	470	1800
Santa Barbara	2140	2390	970	465	1638

\*Approx weights.

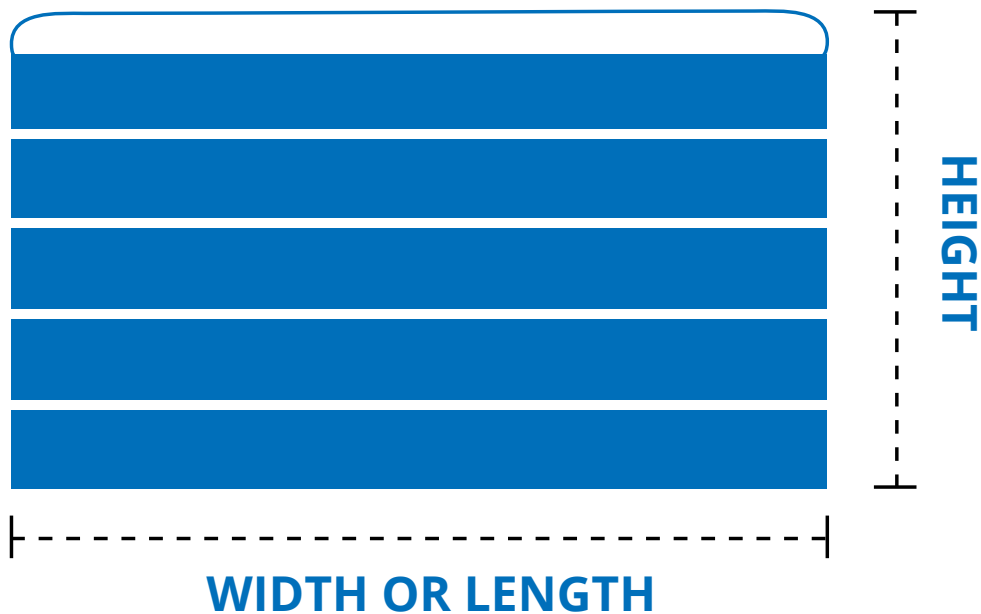

*For Spa Pool Litres, subtract dry weight from filled weight.*

# Positioning

## Foundation & Base

A Spa Pool can weigh between 1-3 tonne when filled with water and therefore requires a sturdy foundation. This needs to be a flat, level surface that supports the entire weight and can handle water spillage.

The Ideal surface is a concrete pad with a minimum depth of 100mm and is sized to the width and length of your desired Spa Pool.

**WARNING:** A Spa Pool cannot be placed on grass, shingle or uneven surfaces. Such foundations may void warranty.

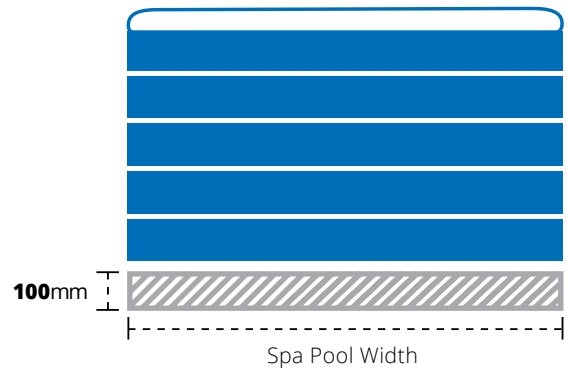

## Steps

If included, a pair of steps should sit on the same level surface as the Spa Pool for safe access. Consider extra foundation to suit.

Steps are usually placed on the 'front side' of the Spa Pool but can be placed any side.

Our new two-tier steps measure:  
600 x 665mm (W X D)

Our classic two-tier steps measure:  
890 x 600mm (W X D)

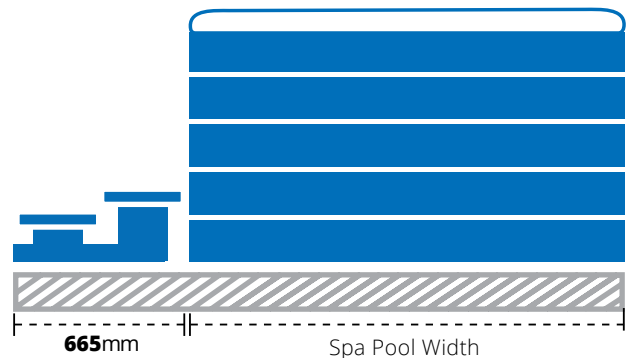

## Heat Pump

Compatible with our Alpine Spa range, a SpaNet 5.5kW heat pump is an excellent accessory to add to your Spa Pool, especially the larger models with higher water volumes. Heat pumps heat your Spa Pool quickly and efficiently, saving money on power!

The heat pump measures:  
955 x 400 x 550mm (L x W x H).

There is specific positioning and air-space requires to adhere to if adding a heat pump. Please talk with your sales consultant for more info.



# Cover Lifters

Cover lifters are helpful accessories which assist with the removal and replacement of your Spa Pool cover. We highly recommend adding a cover lifter to your Spa Pool as it allows the cover to be opened and shut with just one person. It also keeps the cover off the ground which protects the it in the long run.

We have two options available - both perform the same function but operate in different ways to suit different size Spa Pool models.



## VX3 "Top Mount" Cover Lifter

This lifter mounts at the back of the spa pool, towards the top of the cabinet and suits most square/rectangle Spa Models.

500mm of clearance behind is required for the lifter to operate.

150mm each opposite side is required for the mounts.

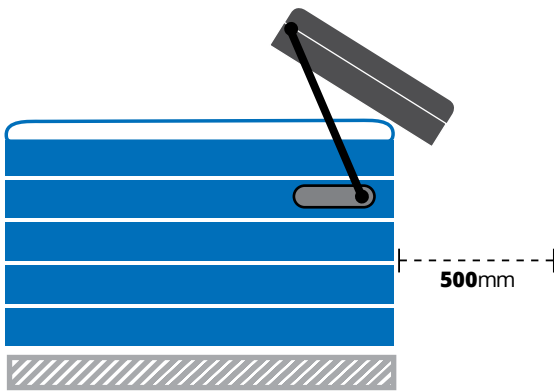

Side on View

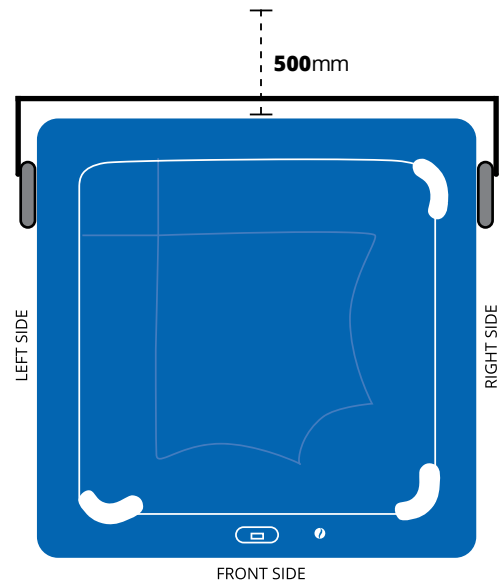

Birds Eye View

## Cradle Cover Lifter

This lifter mounts behind (and under) the Spa Pool.

Recommended for circular models.

800mm of clearance is required for the lifter to operate.

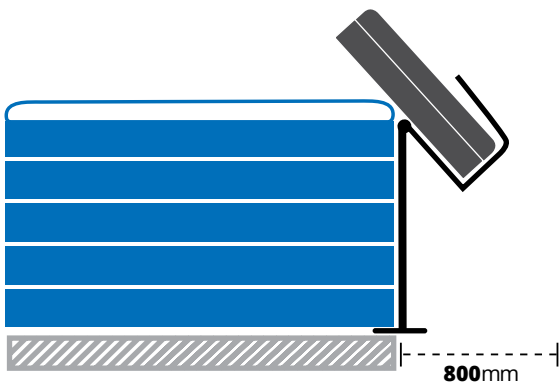

Side on View

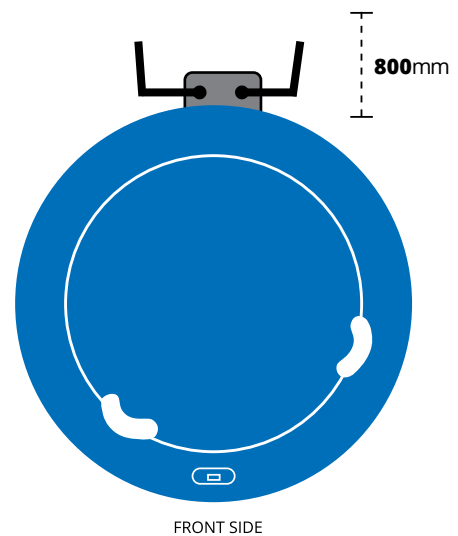

Birds Eye View

Check and confirm which cover lifter is suitable for your Spa Pool of choice. Certain models may require additional modifications or instructions.

# Enclosing the Spa Pool

## Factors to Consider

Whether you want to add decking around your Spa Pool, place one or more sides up against a wall or lower it partially into the ground there are important factors to consider when planning.

- Foundation requirements stay the same however drainage may need to be reconsidered to avoid any pooling of splashing water.
- Access (as described on page 4) is required to the surrounding cabinet panels therefore removable decking pieces or canter-levering should be utilised. You may need to move your Spa Pool into a position from where it can be serviced.
- Covers clips are to be installed on the cabinet to keep the cover secure. How or where will these attach and be accessible?
- There is an external drainage valve located at the bottom of a cabinet panel, this will need to be accessible to drain your Spa Pool every 3-4 months.
- Would accessories such as a cover lifter be obstructed?

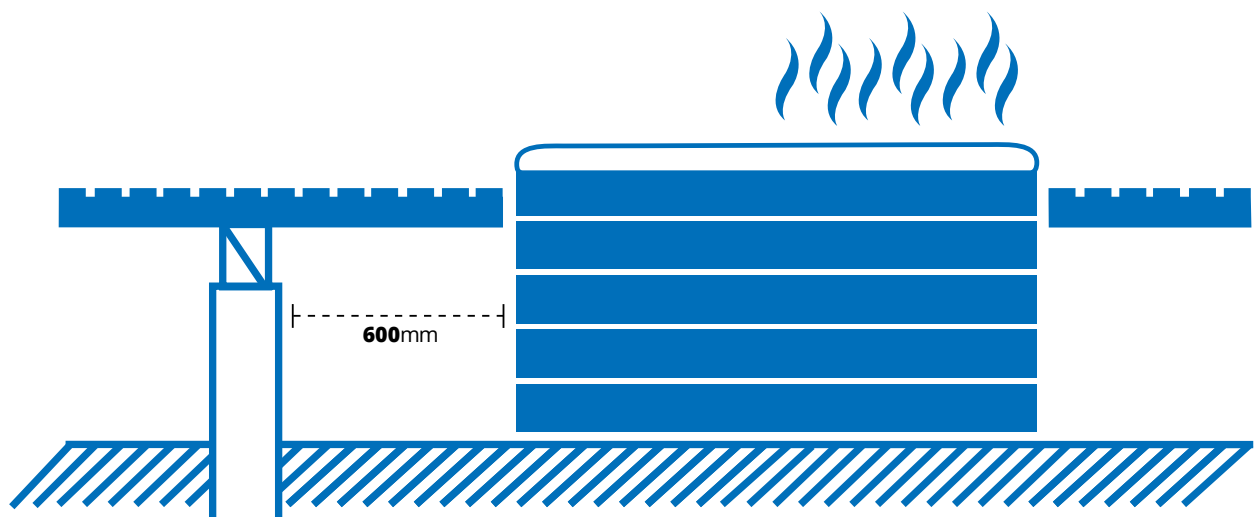

## Walls

The perfect spot to position your Spa Pool may be up against a wall of your home or perhaps a fence. Please read through the 'Factors to Consider' on the previous page to check that none of these requirements will be impeded. You can work around having to allow access (page 4) on that particular side as long as you are prepared to move your Spa Pool away from the wall for servicing if it becomes required.

When drained and on a smooth foundation with clear space, pushing the spa pool away from a wall is achievable with 2-3 persons. Note that this would need to be carried out before any service persons arrived.

## Decking

If your planning on building a deck around your Spa Pool entirely or even just partially, the access requirements as per page 4 still apply.

If you plan to deck up to the acrylic edge as per the diagram, then cantilevering decking pieces is likely the best option to keep 600mm of perimeter clearance. One section of the deck would need to be removable to allow for access under the deck and to the spa. Please check the list of 'Factors to Consider' on the previous page to account for all variables.

Partial (only 1-2 sides) decking usually presents little issues as long as the cabinet panels on those sides can still be removed properly.

## Sinking

Installing a Spa Pool below ground requires considerable planning and expertise. We do not recommend lowering more than a quarter of the spa into the ground unless you can fully adhere to the access requirements outline on page 4 & 9.

The biggest issues with sinking a Spa Pool is access and drainage. You will need to incorporate a 600mm perimeter of space around the spa pool or be prepared to lift it out of the hole to be serviced.

We recommend against sinking the entire Spa Pool below ground however if it is still feasible to achieve this after considering the requirements we recommend consulting an expert landscaping team to undertake the job. We have documents available which roughly details the steps and what is required.

Please advise your sales consultant of any sinking or decking plans - we are here to help!

# Electrical Installation

---

A Spa Pool requires different electrical connections depending on their size and components. Please confirm your full electrical requirements with a licensed electrician.

We always recommend booking an electrician a day or so **after** the Spa Pool arrives.

A guide and diagram for wiring the Spa Pool is usually on the system controller panel but a copy can be found in the user manual or on our support downloads web page.

## Installing a 15A Spa Pool

A 15A Spa Pool requires an outdoor 15A electrical socket. An RCD should be installed to protect the circuit and spa pool.

Some models have a 15A cable & plug included which is 4.5m in length and is pre-wired into the control system within the Spa Pool cabinet. See table on following page for list of models and requirements. Be sure to check with your sales consultant as to the location of the control system on your desired model.

## Installing a 25A+ Spa Pool

Our Spa Pool models that are 25A or higher require a dedicated electrical feed from your switchboard to the Spa Pool system controller. There is no cable included and an electrician must undertake this job to install all required components (cable, isolation switch, RCD etc.). Please confirm with them what is required.

Generally two visits are required for this setup. The first visit would be installing the cable and components from the switchboard to the Spa Pool area, and the second visit finishing the connection to your Spa Pool once it has arrived.

## Load Shed

Most Spa Pool models have some form of load shedding applied by default so that the current being drawn is not an excessive load. Load shedding occurs on the heater when other components are switched on e.g. a 15A model will load shed the heater element when the main 3HP jet pump is run.

We recommend leaving the default load shed setup as is however you can supply a larger electrical feed and switch it off. Bear in mind that switching off load shed on a 15A model (changing it to a 25A) would require a dedicated feed wired to your switchboard.

Please advise your sales consultant if you wish to disable load shed. All Spa Pools are shipped with the "Default Amp" setup and do not require changes to dipswitches.

Note: It is not possible to plug a Spa Pool into a regular 10A house socket.  
Support manuals available at <http://alpinespas.co.nz/support/>

# Electrical Requirements by Model



Model Name	Default Amp (Recommended)	High Amp No Load Shed	Cable & Plug	3 Phase Available
<b>Fuji</b>	15A	25A	Included	No
<b>Colorado</b>	15A	25A	Included	No
<b>Nepal</b>	15A	25A	Included	No
<b>Utah</b>	15A	25A	Included	No
<b>Nordic</b>	15A	25A	Included	No
<b>Alaska</b>	15A	25A	Included	No
<b>Yukon</b>	15A	25A	Included	No
<b>Montana</b>	15A	25A	Included	No
<b>Vermont</b>	15A	25A	Included	No
<b>Makalu</b>	15A	25A	Included	No
<b>Matterhorn</b>	15A	25A	Included	No
<b>Lucania</b>	15A	25A	Included	No
<b>Sierra</b>	25A	N/A	No - Requires Hardwire	No
<b>Vancouver</b>	25A	N/A	No - Requires Hardwire	No
<b>Munro</b>	25A	N/A	No - Requires Hardwire	No
<b>K2</b>	32A	N/A	No - Requires Hardwire	Yes

ALPINE SPAS



Model Name	Default Amp (Recommended)	High Amp No Load Shed	Cable & Plug	3 Phase Available
<b>Zurich</b>	15A	25A	Included	No
<b>Monaco</b>	15A	25A	Included	No
<b>Santorini</b>	15A	25A	Included	No
<b>San Marino</b>	15A	25A	Included	No

PURESPAS

Model Name	Default Amp (recommended)	High Amp No Load Shed	Cable & Plug	3 Phase Available
<b>San Miguel</b>	15A	25A	No - Requires Cable/Plug	Yes
<b>Bar Harbor</b>	15A	25A	No - Requires Cable/Plug	Yes
<b>Honolulu</b>	15A	25A	No - Requires Cable/Plug	Yes
<b>Miami</b>	15A	25A	No - Requires Cable/Plug	Yes
<b>Seattle</b>	15A	25A	No - Requires Hardwire	Yes
<b>Boston</b>	32A	32A	No - Requires Hardwire	Yes
<b>Grand Canyon</b>	32A	32A	No - Requires Hardwire	Yes
<b>Santa Barbara</b>	32A	32A	No - Requires Hardwire	Yes

MASTER SPAS

## Positioning the Cable

Some thought needs to be given to the pathway your cable will take from the system controller within the Spa Pool to the connection point outside. As every customer's requirements are different there is no pre-cut exit hole in the cabinet for cable to pass through.

There's two options available for handling the cable pathway:

### Cable through Cabinet

A 40mm grommet is provided with your Spa Pool that can be installed into the cabinet wall to allow a cable to be fed through. This requires the use of a 40mm hole-saw and glue to hold the grommet in place.

If your electrician is around at the time the spa arrives, you can request for them to drill a hole with a drill bit the same size as the cable and feed it through to achieve a tighter fit and avoid using the grommet altogether. For a 15A Spa Pool, the pre-attached cable would just need to be unwired first from the system controller, fed through the drilled hole and then rewired as the plug head will not fit through.

### Cable through Base

To conceal the cable some customers opt to feed it up through the base of the Spa Pool instead of feeding through the cabinet. This option is usually for hardwiring as cable must be laid before the Spa Pool arrives. The cable also needs to be in conduit and built into the concrete foundation in the correct position!

When your Spa Pool is moved into position it must be lowered down carefully over the conduit 'stub' and have a hole drilled in the base at the same time. To achieve this, the particular corner needs to be propped up on a block, conduit feed up through base, and then gently lowered down over the stub while removing the block.

The following table lists confirmed "safe areas" where there is space inside the cabinet to bring the conduit through without hitting any components or pipes. Apply this measurement to your foundation using the dimensions of the spa pool and the safe space area provided.



# Safe Areas for Conduit



Model Name	Corner	Distance
<b>Fuji</b>	Front Right	200mm
<b>Colorado</b>	Back Left	200mm
<b>Nepal</b>	Back Left	200mm
<b>Utah</b>	Back Left	200mm
<b>Nordic</b>	Front Left	200mm
<b>Alaska</b>	Back Right	200mm
<b>Yukon</b>	Enquire	N/A
<b>Montana</b>	Back Left	200mm
<b>Vermont</b>	Back Right	200mm
<b>Makalu</b>	Back Left	200mm
<b>Matterhorn</b>	Back Left	200mm
<b>Lucania</b>	Enquire	N/A
<b>Sierra</b>	Back Right	200mm
<b>Vancouver</b>	Back Right	200mm
<b>Munro</b>	Back Right	200mm
<b>K2</b>	Back Left	200mm

ALPINE SPAS

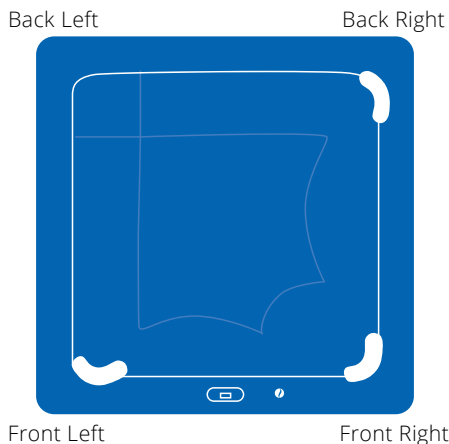

*Note: for reference, the side with the topside control panel is always considered the "front side" of the Spa Pool. The distance is the measurement from the corner to the "safe area".*

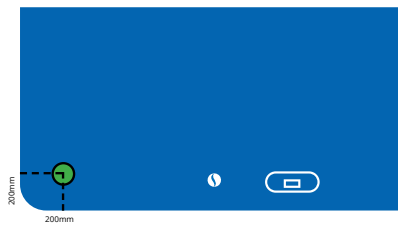

*Nordic Example  
(Zoomed front left corner)*



**Please enquire for Master Spa safe area measurements.**



**Please enquire for PureSpas safe area measurements.**

A list of legacy models is available on the following page.

## Legacy Models

Name	Width (mm)	Length (mm)	Height (mm)	Dry (kg)*	Filled (kg)*	Amp*	Safe Space*
Lux3 (Bliss3)	1500	2000	760	240	890	15A	BL 200mm
Fiesta4 (Eden4)	1600	2120	850	265	1065	15A	BL 200mm
Splash6 (Retreat6)	1980	1980	860	280	1115	15A	FL 200mm
Revive5 (Dream5)	1980	1980	860	280	1230	15A	FR 200mm
Grand6 (Escape6)	2280	2280	880	430	1750	25A	FR 200mm
Duo	1000	2130	740	177	672	15A	BR 200mm
Mont Blanc	2000	2000	880	330	1225	15A	BL 200mm
Aspen	1600	2130	850	320	1115	15A	FR 200mm
Blackburn	2000	2000	900	360	1360	15A	FR 200mm
Summit	2000	2000	880	380	1380	15A	BR 200mm
McKinley	2190	2910	900	400	1850	25A	BR 200mm
Elbrus	2110	2110	900	420	1570	25A	BR 200mm
Everest	2280	2280	990	480	1945	32A	BR 200mm
Cub	1600	2130	870	350	1120	32A	FR 200mm
Frontier	2000	2000	900	390	1560	32A	BR 200mm
Oasis	2280		900	450	1770	32A	Enquire
Arctic	2280	2280	930	495	1895	32A	FL 200mm
Glacier	2280	2280	920	495	1895	32A	BR 200mm
X80	2750	2280	1000	590	2460	32A / 45A	FR 200mm
X90	3000	2280	1020	620	2985	32A / 45A	FL 200mm
Maui	1980	1520	760	181	938	15A	FL or FR 250mm
Nevis	2130	1980	860	308	1480	32A	FL or FR 250mm
Isla Margarita	2740	2310	910	454	2536	32A / 45A	FL or FR 250mm
Hawaii	2140	1980	860	308	1480	15A	250mm
Antigua	2130	2130	910	383	1802	32A	250mm
Captiva	2130	2130	910	383	1897	32A	250mm
Barbados	2310	2310	910	412	2115	32A	250mm
Grand Bahama	2310	2310	910	430	2133	32A	250mm
Dove Canyon	2310	2310	960	476	2009	32A	250mm
Eagle Crest	2130	2130	960	405	1673	32A / 45A	FL or FR 250mm

\* All weights are approx. Amperage is default setup however high amp (no load shed) settings may be available. Confirm all electrical requirements with your salesperson and electrician. Safe spaces for conduit through base are marked as front left, front right, back left, back right from the perspective of the front of the Spa Pool (touch panel) as per page 14. Please let us know if your desired model is not listed.

# Alpine Gazebo

Carefully designed to compliment almost any landscaping or garden design, our gazebo is the perfect addition to your backyard. If adding to your setup, be aware your foundation requirements will be a larger size as per below diagram 'K' and 'L'.

## Setup Dimensions:

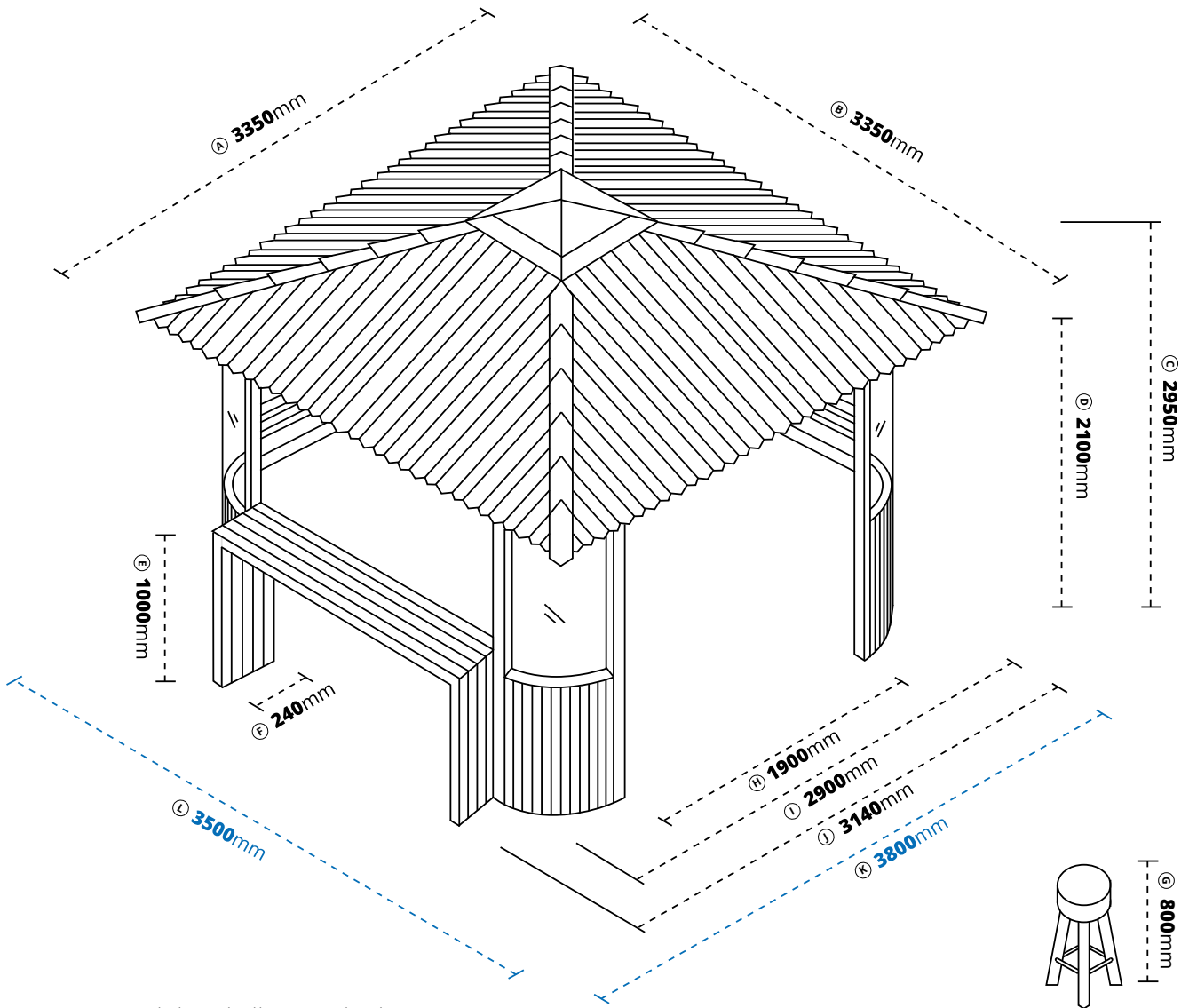

Bar is modulated allowing the bar/entrance to be configured on either side.

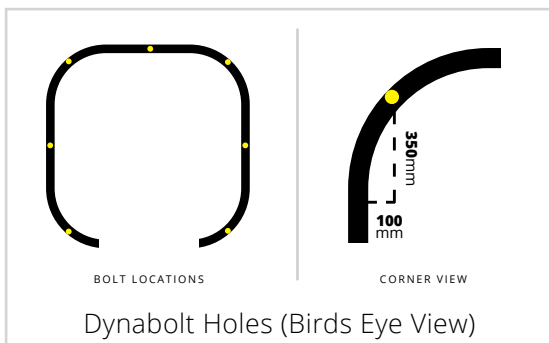

- A. Roof width
- B. Roof length
- C. Ground to roof peak
- D. Ground to roof edge
- E. Bar height
- F. Bar width
- G. Stool height

- H. Gazebo opening width
- I. Gazebo width
- J. Gazebo with bar width
- K. Suggested concrete pad width to leave room for stools
- L. Suggested concrete pad length to leave room for spa pool steps (if included).

*For access requirements and how accessories work within the Gazebo, talk with your Sales Consultant.*

# Notes

A series of horizontal dotted lines for writing notes.

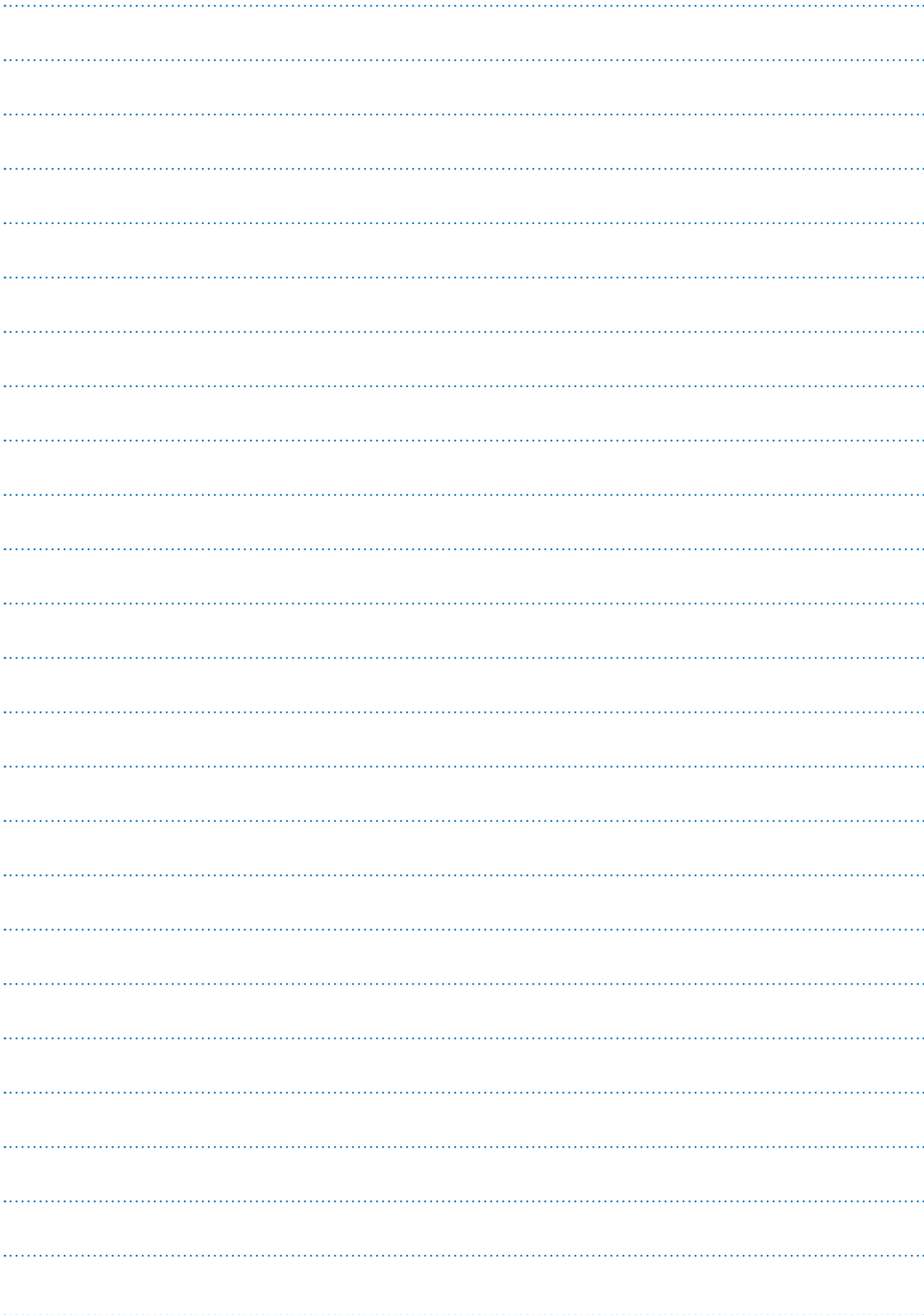

# Sketch



# Order Checklist

Below is a checklist with some important steps to guide you through your new spa pool purchase:

## Order Details

Ensure your order details are correct. Please check the delivery address, contact phone numbers & email address are correct as well as the model & colour of the Spa Pool.

## Payments

Balance payments need to be settled a minimum of one week prior to dispatch date to provide opportunity to book in preferred freight/delivery method.

## Delivery Method

Are you fully aware of what is included in your chosen delivery option?

Manpower or Hiab Delivery - Has Alpine Spas received a clear description/photos of your full delivery path?

Freight Provider Delivery (Curbside / Depot) - Delivery can take 3-5 business days from the dispatch date on your order. Deliveries to your property are only contracted to the curbside - The delivery team will take it down the driveway if the driver deems it accessible.  
*\*Failing to disclose all relevant delivery information may result in addition charges.*

## Spa Placement

If your delivery is within two weeks:

- Are the foundations complete?
- Have you determined the final placement and direction you want the Spa Pool facing?
- Do you have 600mm clearance around the Spa Pool's final position?
- Have you allowed room for your cover lifter (if purchased)?

## Installation (Nationwide Deliveries)

Unless you have opted for our Gold Elite delivery option, upon delivery you will need to be prepared to:

- Remove and dispose of the packaging and pallet the Spa Pool is delivered on.
- Install accessories (cover lifter etc. if purchased) as these do not come attached. They do come with assembly instructions. You will need a drill, socket set, spanners and a measuring tape to complete installation.
- Fit the cover as it does not come attached. You will need a drill to attach the cover clips to the spa to enable you to lock cover on securely.
- Steps require simple assembly.

## Electricians & Wiring

Manpower or Hiab Delivery - Electricians or Water Delivery teams should be booked for the day after delivery in the rare instances there are delays.

Freight Provider Delivery (Curbside / Depot) - Please allow at least 7 business days from the date of dispatch or wait for the spa to arrive.

## Water Testing

All our Spa Pools are water tested. While they are completely drained, sometimes there can be a little bit of water left in the pipes which can come out during the freight process. This may mean there is a bit of water in the pool when it arrives.

# Spa Pool Pre-Delivery Guide



[www.alpinespas.co.nz](http://www.alpinespas.co.nz)

0800 99 33 88