



alpine**spas**™



Cedar Barrel Sauna

Assembly Manual



Follow along build **VIDEO** available from our Alpine Spas support page:
<http://alpinespas.co.nz/support>





1	Before You Start	1-4
	Location.....	1
	Oiling The Timber.....	1-2
	Electrics - Light.....	3
	Electrics - Heater.....	4
2	Important Safety & General Information	5-6
	Safety & Operation.....	5
	Nature of Barrel Saunas.....	6
	Warranty.....	6
3	Pre-Assembly Checks	7-10
	Parts List.....	7
	Parts Labeled.....	8
	Foundation.....	9
	Tools & Resources.....	10
4	Installation Instructions	11-26
	Base.....	11-12
	Bottom Section.....	13
	Front and Back Panels.....	14-16
	Front and Back Panels + Staves.....	16
	Sauna Barrel Staves.....	16-17
	Steel Strap Connection.....	18
	Glass Door.....	19
	Door Lock.....	19
	Outdoor Bench.....	19-20
	Indoor Bench.....	20
	Towel Rack.....	20
	Outdoor Shelf.....	21
	Outdoor Floor Panel.....	21
	Heater Fence.....	21
	Heater.....	22
	Vent Installation.....	23
	Indoor floor panels.....	23
	Back Rests.....	23
	Bitumen Roof Installation.....	24-25
5	Technical Support Contact	26
	Contact Information.....	26

1. BEFORE YOU START



IMPORTANT! READ THIS SECTION ENTIRELY BEFORE PROCEEDING WITH INSTALLATION.



INSTALLATION VIDEO AVAILABLE!

Watch online - visit our support page at:
<http://alpinespas.co.nz/support>

LOCATION

Think carefully about where you want to locate the sauna. After you have completed the installation the sauna won't be able to be moved due to its size and weight. The sauna will need to be in a location that can have power access installed. Confirm the electrical supply with your electrician before building the sauna.

OILING YOUR SAUNA TIMBER

Wood being a natural product, requires regular maintenance to protect it and keep it looking good. Any wood product that is exposed to the sun in New Zealand needs regular surface treatment with a U.V protectant timber oil.

The cedar is supplied unoiled. As part of the ownership of a natural wood product, you must also be prepared to re-oil the external surfaces of cedar up to every 6 months (frequency will be determined by location and exposure to sunlight).

Leaving the sauna unoiled will see discolouration of the wood and will cause it to dry out, increasing the chances of cracking or splitting.

Only the external facing wooden surfaces need to be oiled. Never oil internal surfaces.

We recommend a 'clear coat timber protectant oil' such as 'CD-50'. Available from hardware stores such as Mitre 10 or Bunnings.

Simply oil using a paintbrush and brush on an even coat. Follow the product application and preparation directions.

To oil all external surfaces you will need a fair amount of product. It is worth just getting up to 10 litres of product as you will need it again to repeat in 6 months' time.



We recommend oiling the external surfaces *before* assembling the Sauna. Allow the oil to dry completely before continuing onto installation. It is possible however to oil post assembly, but it will not be as easy to access certain parts.



THE FOLLOWING PARTS NEED TO BE OILED:

Staves

All of the staves need oil applied. Oil the exterior surfaces ONLY.

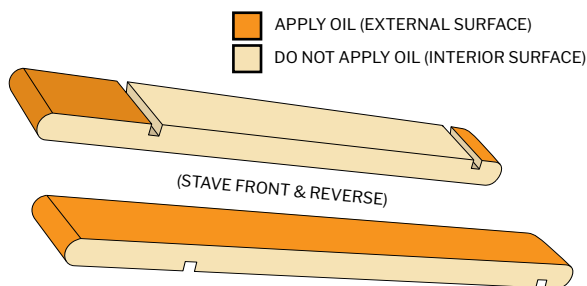

Front & Back Wall

Oil ONLY the exterior facing surfaces of the front and rear panels. The images below show the interior surface of these panels which must be left unoiled.



Cradle Bases & Support Beams

Fully oil all sides of the three cradle bases and the four support beams.



External Accessories

Fully oil the towel hook, shelf, outdoor bench seats + support legs and the outdoor floor panel. These items can be oiled at a later time if required.



Front & Rear Capping

Fully oil both sides of the front and rear capping.



Outdoor Back Rests & Bench Seats

Fully oil both sides of the outdoor back rests and the outdoor bench seats.

1. BEFORE YOU START

ELECTRICS - LIGHT

Equipment

Lighting for the sauna is provided in the form of a sauna light-case and a light bulb, however no lighting cable or switch is provided as every setup location is different. The sauna light case meets ASNZS3000 electrical installation standard, is IPX4 rated and fully sealed.

An electrician is required to install the light and provide the necessary light cable plus switches and any other components to power the light.



CONSIDERATION MUST BE MADE FOR THE SAUNA LIGHT & CABLE BEFORE ASSEMBLING.

Setup

We recommend having the electrician install power and switch separately for the light so that it operates independently from the heater. A switch on the outside of the sauna is the ideal scenario, turning on the light before you enter.

If your electrician is not on site during the time of build, you will need to install a placeholder cable/cord into the provided cable channel (**see steps 18 - 19**), as once you have moved past this step you will not be able to wire up the light easily. This will allow the electrician to pull through light cabling at a later time. Note that the channel cable feeds out through the bottom of the sauna and requires a hole to be drilled in the corresponding stave.

The default light position is located on inside of the front wall, on the right-hand side (when standing inside, looking out of the sauna).

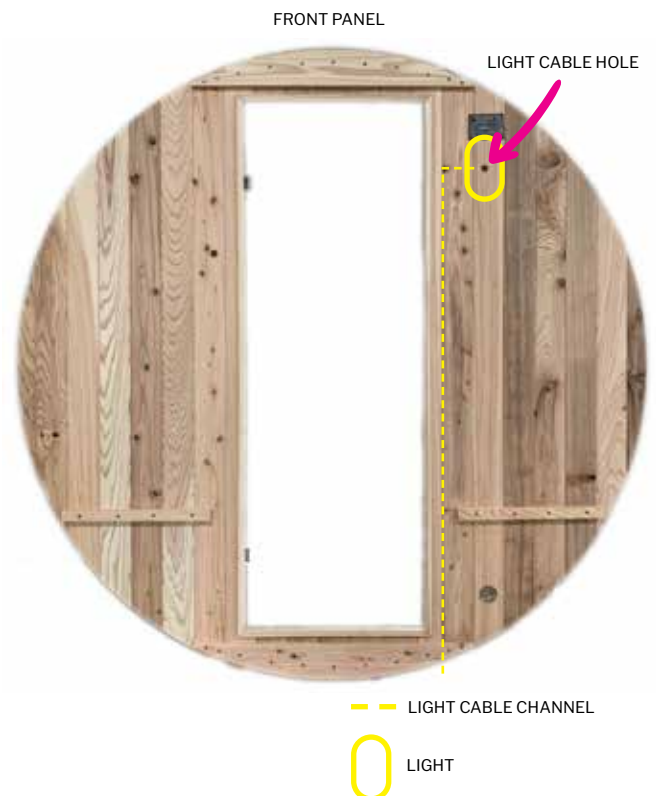



ELECTRICS - HEATER

The provided sauna heater must be installed by a registered electrician. No wiring, switches, RCD or electrical accessories are included.

Heater Model

Sawo Sauna Heater 4.5kW - Model SCA-45NB.

Setup

Install the heater as per the manufacturer instructions included, along with any electrical protective devices. The heater is to be mounted near ground level on the 'back wall' and surrounded by the provided wooden heater fence.

Cable for the heater can be fed through the back of the sauna through the provided pre-drilled hole (see image below).

For single phase installations, lines 1, 2 and 3 should be looped together with phase into L1 per the diagram below.

SCA-45NB
SCA-60NB
SCA-80NB
SCA-90NB

1 VAIHE / 3 VAIHE
1 PHASE / 3 PHASE

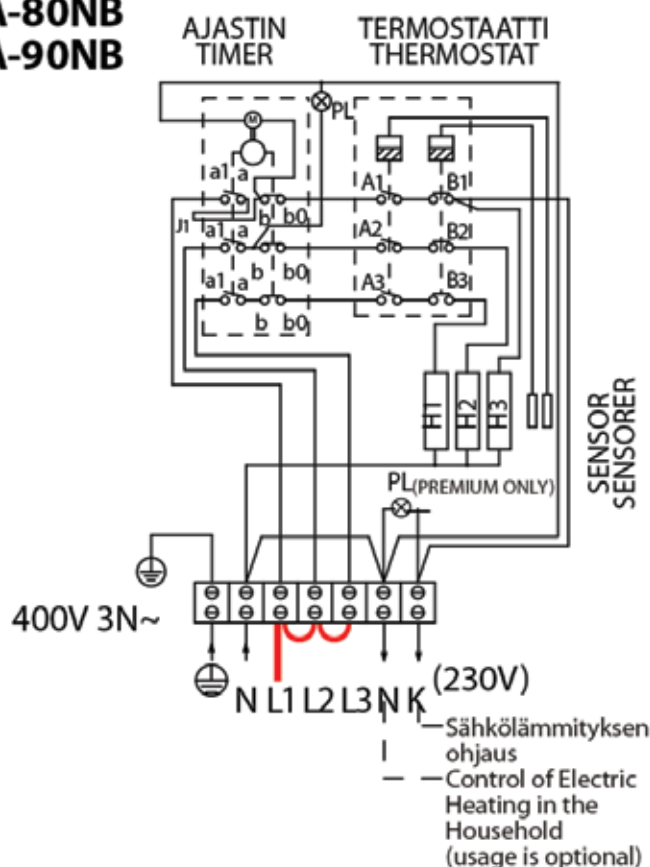

BACK PANEL



POWER CABLE HOLE FOR HEATER

2. IMPORTANT SAFETY & GENERAL INFORMATION



PLEASE READ ENTIRE MANUAL THROUGH BEFORE PROCEEDING WITH INSTALLATION.

SAFETY & OPERATION

Read all health and safety instructions. If unsure about your health concerns, consult with your physician prior to use. If you feel light-headed or heat exhaustion during session, exit the sauna immediately.

1. Read and follow all instructions carefully.
2. When installing and using the electrical equipment, basic safety precautions should always be followed.
3. To reduce the risk of injury, do not allow children to use the sauna unless they are closely supervised at all times.
4. Do not use the sauna immediately following strenuous exercise. Wait at least 30 minutes to allow the body to cool down completely.
5. Excessive temperature has a high potential for causing fetal damage during the early months of pregnancy. Pregnant or possibly pregnant women should contact their physician prior to using the sauna.
6. Hypothermia Danger: Prolonged exposure to hot air will induce hypothermia. Hypothermia occurs when the internal temperature of the body reaches a level several degrees above the normal body temperature of 37°C. While hypothermia has many health benefits, it is important not to allow your body's core temperature to rise above 39.4°C. Symptoms of excessive hypothermia include dizziness, lethargy, drowsiness, and fainting.
7. The use of alcohol, drugs, or medications prior to or during the sauna session may lead to unconsciousness.
8. Persons suffering from obesity or with a medical history of heart disease, low or high blood pressure, circulatory system problems, or diabetes should consult a physician prior to using the sauna.
9. Persons using medications should consult a physician before using the sauna since some medications may induce drowsiness while others may affect heart rate, blood pressure, and circulation.
10. Never sleep inside the sauna while the unit is in full operation.
11. **DO NOT** use any type of cleaning agents on the interior of the sauna.
12. **DO NOT** stack or store any object on top of or inside the sauna.
13. If power supply cord becomes damaged it must immediately be replaced by a service technician. Please contact your local dealer for assistance.
14. **DO NOT** use the unit during an electrical storm, as there is a remote risk of shock.
15. Altering or tampering of any electrical connections on the power supply will void the manufacturer's warranty.
16. Dry your hands before handling electrical controls. Never unplug the power cord or adjust the controls with wet hands or when you have wet bare feet. A danger of electrical shock exists.
17. **DO NOT** attempt any repair without consulting the manufacturer first. Unauthorized repair attempts will void the manufacturer's warranty.
18. All natural wood articles have variations in the color, grain, and irregularities such as knots, and fine cracks. These characteristics are a part of the natural beauty of the wood, and in no way should be considered defective.



DOWNLOAD THE OUTDOOR SAUNA USER & MAINTENANCE GUIDE

**ALPINESPAS.CO.NZ/SUPPORT
OR SCAN QR CODE WITH SMART PHONE**

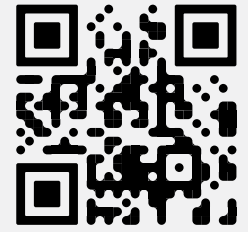

WOOD & EXPECTATIONS

This Cedar Barrel Sauna is designed for outdoor use.

The lumber is naturally resistant to the elements. Rain and sun will not damage the wood, although natural weathering and coloring of the wood will occur over time.

The cedar is knotty cedar, so expect there to be slight imperfections and knots, this gives the barrel sauna its beautiful rustic look and feel. Because of the knots and being softwood, the staves will tend to bend out of line on their own. This is completely normal and will be self corrected as the Sauna is built.

Properly assembled, you should not experience water dripping into the sauna. However, you will experience water seepage, especially on the top and sides of the sauna. This is because of the porous characteristics of the wood and due to the ball-and-socket profile design of the staves.

Water seepage WILL NOT hurt the sauna and in most cases will dry quickly in the hot, dry environment when the sauna is in use. If you wish to keep your sauna completely dry at all times, then you should place it under a covering or structure with a roof. Light sanding will help to alleviate water stains.

WARRANTY

INDOOR SAUNAS*: Alpine Spas warrant the workmanship against defects in materials and workmanship for a two-year period from date of delivery. Electronics and parts also carry a 2-year warranty.

OUTDOOR SAUNAS*: Alpine Spas warrant the workmanship against defects in materials and workmanship for a 5-year period from date of delivery. Electronics and parts also carry a 2-year warranty.

**After 12 months this warranty is limited to supply of replacement parts and excludes labour.*

3. PRE-ASSEMBLY CHECKS

PARTS LIST

Installation Parts

Part Name	Label*	Qty
Regular Staves	1	62
Starting Bottom Stave	2	1
Final Top Stave	3	2 (two sizes)
Front Edge Capping	4	7
Rear Edge Capping	5	7
Front Panel Part 1	6	1
Front Panel Part 2 (Door)	7	1
Front Panel Part 3	8	1
Back Panel Part 1	9	1
Back Panel Part 2	10	1
Back Panel Part 3	11	1
Panel Set Securing Pieces	12	4
Cradle Base	13	3
Cradle Base Supports	14	4
Base Support Screw Set	-	1 Bag

Part Name	Label*	Qty
Inside Floor Panel	15	2
Outside Floor Panel	16	1
Glass Door	17	1
Glass Door Hinges	18	2 Set
Door Handle, Magnet & Lock	19	1 Set
Inside Bench	20	2
Inside Bench Support Beam	21	2
Inside Bench Legs	22	2
Outside Bench Seats	23	2
Outside Bench Support Beam	24	2
Outside Bench Legs	25	2
Triangular Roof Beam	26	2
Heater Fence	27	1 Set
Steel Bands	28	3 Sets
Screws	-	1 Set

*NOTE: The 'Label' column in the above table corresponds to the following page diagram which identifies the pieces for your reference. The physical items are not numbered. Some pieces however (such as the 'starting bottom stave') are physically stickered with their descriptive part name.

Accessory Parts

Part Name	Qty
Sawo 4.5kW Heater	1
Sauna Heater Stones	1 Set
Door Lock	1 Set
Back Rest	4
Towel Rack	1 Set
Magazine Holder	1 Set
Cup holder	1 Set
Water Bucket	1
Ladle	1
Sand Timer	1
Sauna Vents	9
Hygrometer	1
Bitumen Piece A	34 (+21 Spare)
Bitumen Piece F	10 (+4 Spare)
Bitumen Piece G1	10 (+4 Spare)
Bitumen Piece H	10 (+4 Spare)
Bitumen Piece G2	2 (+1 Spare)
Rubber mallet	1

Screws (Including Spares)

Size	Qty	Description
'4*40mm	245	Panel Set Securing Pieces, Cup Holder, Magazine Rack, Inside Outside Bench, Floor Panels, Front & Back Capping, Towel Rack, Heater Fence, Lower 13 Staves.
'3*30mm	160	Top 51 Staves
'5*70mm	11	Front & Back Panels
'6*35mm Dome Head	5	Heater Fence
'6*75mm Dome Head	3	Door Handle
'3*25mm Dome Head	3	Door Lock
'4*30mm	6	Door Hinges
'3*14mm	5	Magnetic Lock
'3*16mm	500	Bitumen Roofing
M8 Moon Nut	8	Cradle Base Supports
M12 Hex Nut	8	Cradle Base Supports
100mm Double Side Bolt	4	Cradle base Supports
180mm Threaded Bolt	2	Cradle Base Supports
Plastic Caps	8	Cradle Base
Steel Strap Tightening System	3	Steel Strapping



PARTS LABELED

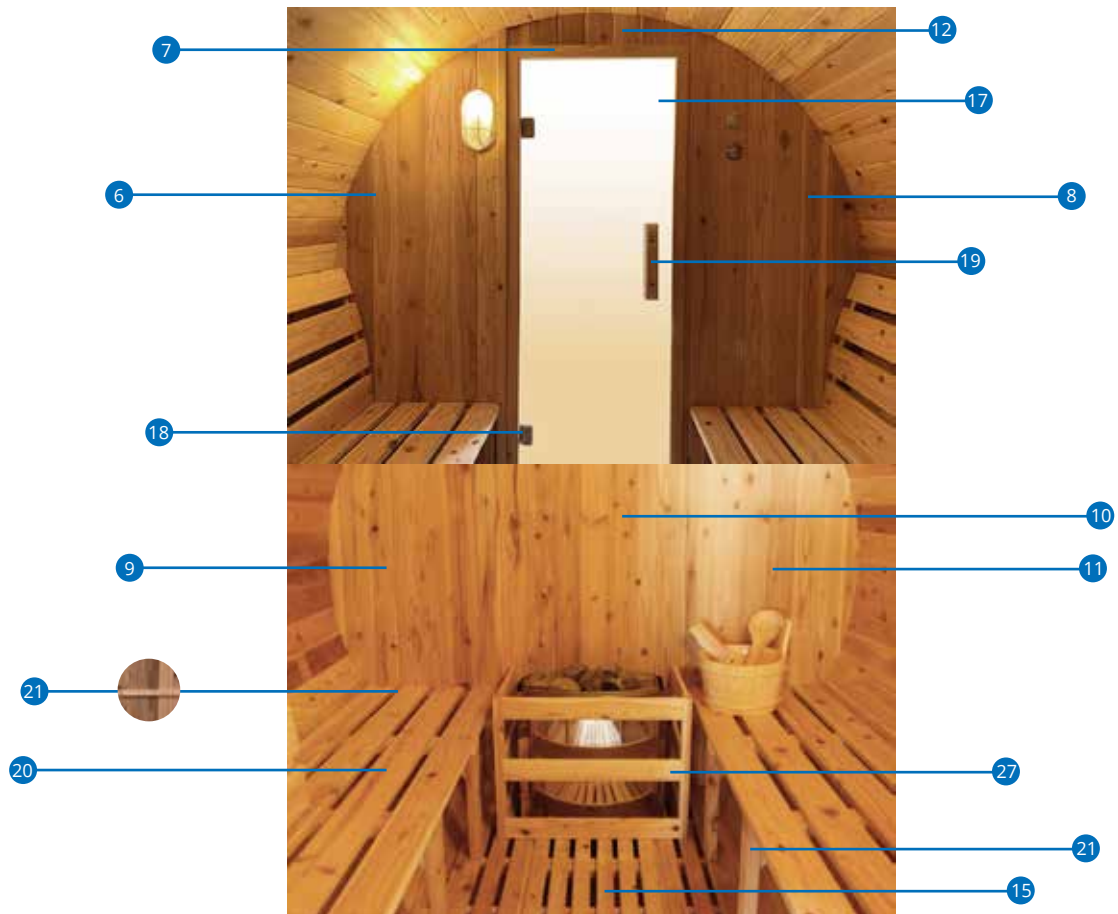

NOTE: Appearance of sauna and particular parts may vary from the diagram shown above.

3. PRE-ASSEMBLY CHECKS

FOUNDATION

Ensure the foundation can withstand the weight of the barrel sauna without subsiding.

We recommend using either a concrete slab or a pile foundation. The base of the sauna must not rest upon anything that will degrade the quality of the timber (soil, grass etc.)



Your foundation should have some form of drainage or contour, allowing storm water to drain away from the base of the sauna.

If you find after creating the foundation that your sauna base does not sit level, use packing shims or similar to correct to level positioning.

The maximum width of the cradle bases is 1500mm.





TOOLS

Tools required include screw drivers set, power drill set, measuring tape, level, mallet, socket set.



MALLET INCLUDED



RESOURCES



TIMBER PROTECTION OIL



WATERPROOF SILICONE FOR BITUMEN ROOF

OPTIONAL



STAPLER ASSISTS WITH ATTACHING BITUMEN ROOFING

4. INSTALLATION INSTRUCTIONS

1. Stand all three cradles bases, equal distance apart matching the length of the four cradle support lengths. Take some time to note the dowels at the ends of the supports lengths, and the grooves in the cradles.



2. The double sided base support screw is used to connect the end cradle base supports to the support lengths. The longer single threaded bolt is used between the centre cradle support.

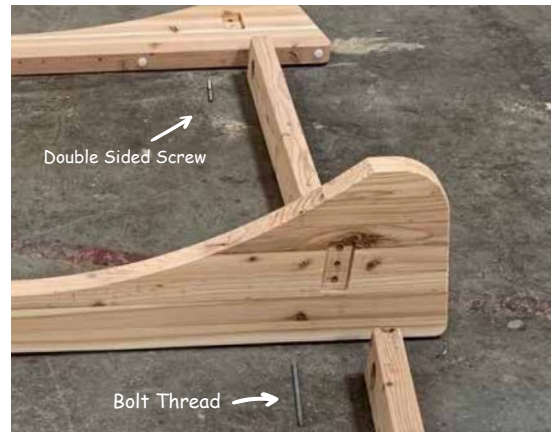

3. Slide the two long bolt threads through each side on the center cradle, so that an equal amount of thread is remaining on each side.

If you use a tool to assist pushing the bolt through, be careful not to damage the thread.



4. Slot all four cradle support lengths onto the four bolt ends on either side of the center cradle. You should see thread emerging through each of the pre-created holes.





- 5.** There are four double ended screws for the end cradle supports. Screw part A, with the broad screw thread, into the end cradle so the bolt end (part B) is left sticking out.

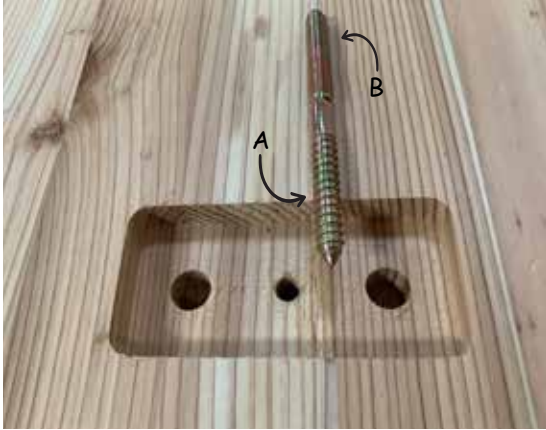

- 6.** Secure the cradle support lengths by placing the half moon steel washer, standard washer and nut on to each thread appearing in the pre-created hole on the side. Tighten the nut using a socket set.



- 7.** Make sure each support is tightly fixed to the cradle. use a tool with a 90 degree edge to make sure each support sits square to the cradle.



4. INSTALLATION INSTRUCTIONS

- 8.** Start by locating the 'bottom stave'. This stave should be labeled but will have two vent holes pre-drilled.

Fit the bottom stave into the centre of the cradle bases using the provided dowels (the rear vent should sit close to the back cradle base and the front vent centered between the front and middle cradle bases).

The cradle base supports mentioned in steps 1-7 do not appear in the following images. (They were a structural addition added at a later date).



- 9.** Next, screw the bottom stave into the cradle base supports using 3x '4*40mm' screws

Note that there are no pre-drilled holes.



- 10.** Lay 6x 'Staves' on either side of the secured 'bottom stave' (a total of 12 staves added). Use a rubber mallet to gently tap the staves tightly together. Ensure the staves are evenly centered in the cradle base and line up flush at the ends with the fixed 'bottom stave'.



- 11.** Use 36x '4*40mm screws' to fix the 12 additional staves across the 3 cradle base supports. 3 screws total per stave (1 screw into each cradle).

Note that there are no pre-drilled holes.



Level the assembly so far. Pack cradle bases with shims where required.





- 12.** Lay out the 'Back Panel Parts 1, 2 & 3' flat on ground with the pre-installed bench supports right side up.

The vent hole identifies the bottom of the back panel.

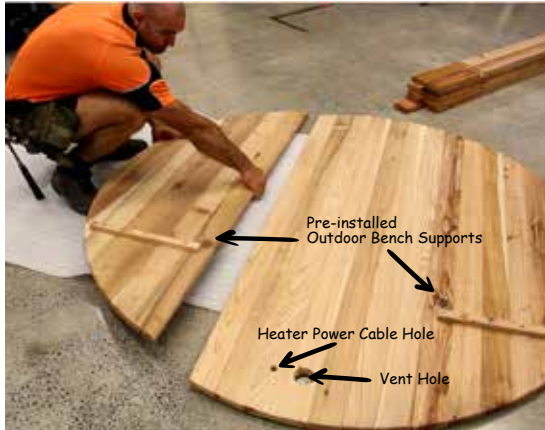

- 13.** Secure the back panels together using 4x '5*70mm Screws' into the pre-drilled holes labeled below at the top and bottom of the panel.



- 14.** Measure the depth of the groove in the 13 staves you have secured.



- 15.** This measurement will be used to mark the indentation distance between each of the four 'panel set securing pieces' and the edge of the front at back panels.



4. INSTALLATION INSTRUCTIONS

- 16.** Use 22x 4*40mm screws to fasten two of the 'panel set securing pieces' to the bottom and top of the back panel, applying the indent measurement (as per step 15) to set the position. Place the completed back panel assembly aside.



- 17.** Layout pieces 'Front Panel Parts 1, 2 & 3'. Notice there are bench supports both on the inside and the outside of the panel. Do not fix together yet.



18. LIGHT

Before moving on and securing the front panels together, consideration must be made for the wiring of the sauna light. The included light/lamp does not come with cable or a switch, these must be provided and installed by an electrician (see page 3).

A cable channel is provided in the 'Front Panel Part 3' as shown below. A place-holder cable should be fed through the light hole and installed flush into the cable channel before screwing the front panel assembly together. This will assist the electrician with the installation of the light cable post assembly.



The cable needs to exit out through a stave at bottom of the Sauna. To achieve this, place the 'Front Panel Part 2' (door frame) into position on the staves.



19. LIGHT (Continued)

Centre the door frame, then pencil a mark as a guide onto the corresponding bottom stave, then remove the panels and drill a hole (size suitable for light cable provided by electrician) down through the stave to underneath the sauna.

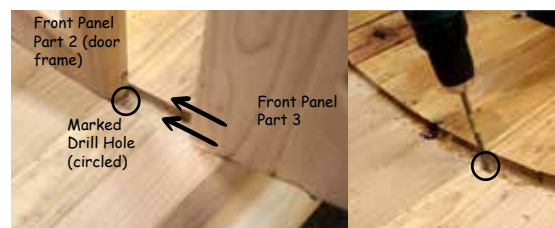

Feed your placeholder cable through the light hole and down through the cable channel in 'Front Panel Part 3'.





- 20.** Secure the front panel assembly together using 3x '5*70mm Screws' into the pre-drilled locations marked (A) below.

Screw the door frame into the side panel using 2x '5*70mm Screws' into the pre-drilled locations marked (B) below.

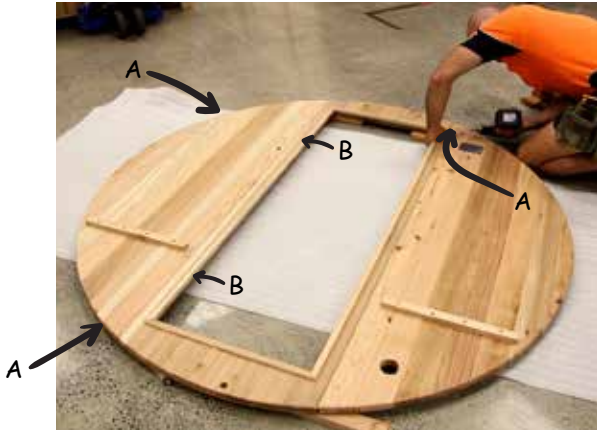

- 21.** Applying the indent measurement from step 14, screw the 2x remaining 'Panel Set Securing Pieces' onto the top and bottom of the front panel assembly using 22x '4*40mm Screws'.

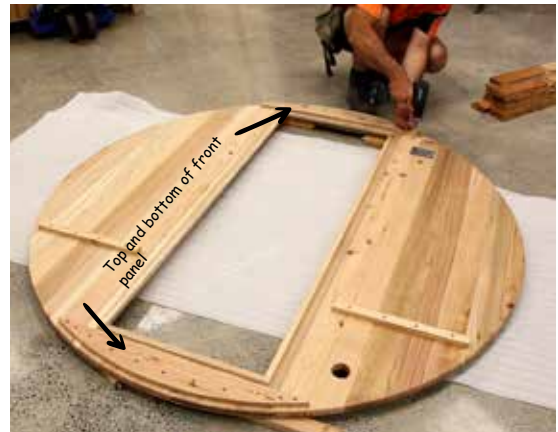

- 22.** Install the front and back panel assemblies into the grooves at their respective ends. Ensure both the base and the bench seat supports remain level by using a spirit level.

A stave can be placed temporarily across the top of the front and back panel to hold them in place.



- 23.** Install 9x more staves onto either side of the barrel. Use a rubber mallet to gently tighten up the staves as you go. Use 36x '3*30mm Screws' to fix the 18 new staves one-by-one to the front & back panels.

Please note: Now the staves are screwed into the front and back wall, the screw position for adding these staves should no longer be centered. The correct positioning for the screw should be across the top edge as per the below diagram. This allows for some movement when adding additional staves, particularly the final top stave.



4. INSTALLATION INSTRUCTIONS

- 24.** Install 16x more staves on either side of the barrel but DO NOT fasten with screws yet. You may need wiggle room to place the last stave - it is designed to be a tight fit.

Use a rubber mallet to gently tighten up the staves as you progress.



- 25.** The remaining gap will be filled with the 'Top Stave' which is available in two smaller stave sizes. Due to natural swelling/shrinking of the cedar wood, one piece is likely to fit better than the other.

Place one of the staves into the gap by lifting the surrounding pieces upwards to create a small arch. Gently push down and use a rubber mallet lightly to tap into place and round out the staves evenly.



- 26.** Once all of the unscrewed staves are sitting correctly, fix them into the front and back panels using '3*30mm' screws.

The staves can continue to be banged into shape with the mallet once the steel strapped have been



- 27.** Uncoil the steel straps. The straps may require some pressure to re-bend so they are curling the correct way. Using a glove, apply the following technique:



Slide 3 steel straps underneath the sauna silver side up, then wrap 3 more steel straps silver side down over the top of the sauna ready to be connected.





- 28.** Familiarize yourself with the strap tightening systems and undo the assembly. Thread the assembly through the two steel strap ends to connect them together. Attach a nut and washer on either side of the thread and lightly tighten. Leave loose so you are able to adjust the steel straps positioning.



- 29.** With all three straps connected, align the back and centre straps up so that they cover the row of screws. The front strap will need to sit behind or forward of the screws if you are exiting the light cable through the bottom of the sauna. Adjust the positioning of the tightening systems to be located somewhere within the lower half of the sauna (to avoid the bitumen roof).

Once complete use a socket set or the equivalent to tighten the straps. Use a wrench of spanner to hold the base nut when fastening.



- 30.** Place a dome hex cap over each end of the threads (6 in total). Remove the blue protective film from the steel straps.



Using the rubber mallet, re-shape the staves if they still required rounding or have moved out of place. Untighten and re-tighten the straps during this process if required.



- 31.** Stand the glass door on a soft surface, then hold the metal hinge piece on the outside face of the glass door and place the clear film over the two pre-drilled holes.

Match the holes with the plate piece and finger tighten the allen key screws provided to hold it into place. Fasten the screws more tightly with the an allen key.



4. INSTALLATION INSTRUCTIONS

- 32.** Place the door's hinges into the two grooves in the door frame, and drill 3x '4*30mm' flat head screws into each hinge securing the door into place.

You may need a block of something soft under the glass door to ensure it does not slip down.



- 33.** Slot the two nodes of the door handle through the glass holes provided, use 2x'6*75mm screws to fix the handles together while squeezing both sides of the handles tight.



- 34.** The door lock is a simple slot, connect and screw system. Slot the handle piece through the pre-drilled hole and connect the locking bar. Secure the lock bar to the handle with 2x '3*25mm' screws.



Install both magnetic lock pieces onto the door using 2x'3*14mm screws.



- 35.** Fix the additional 'outside bench support beams' with 2x'4*40mm screws to sit adjacent to the pre-installed support beam on the front wall. Repeat for the opposite side of the sauna.



Connect an outdoor bench support leg to the outdoor bench seat using the provided dowels.



Place the outdoor bench seat onto the supports.



- 36.** Secure the outdoor bench seat into the bench supports using 4x '4*40mm' screws. Screw down in between the gaps so the screw is hidden.



Next secure the outdoor bench leg using 2x '4*40mm' screws while keeping the bench seat level.



Repeat for the other bench seat.

- 38.** Slot the indoor bench legs into the base of each indoor bench seat using the provided dowels. Secure the legs to the bottom of the barrel staves with 2x '4*40mm' screws per leg while ensuring the bench seats remains level.



- 37.** Place the indoor bench seat inside, resting on the two pre-installed bench supports connected to the front and back panels.

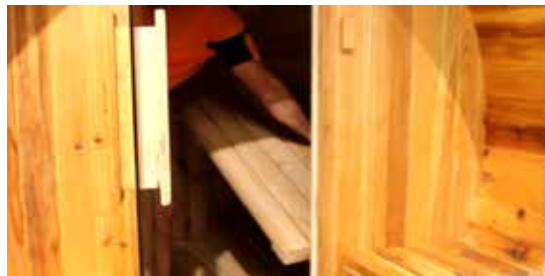

Secure with 4x '4*40mm' screws into the bench supports, two screws on each end of the bench.



Add an 'inside bench seat support beam' on the underside of the bench seat in the centre with 2x '4*40mm' screws.



Repeat for the other bench seat.

- 39.** Align the towel rack at your desired height, then use a drill to secure the rack with 4x '3*30mm' screws.



4. INSTALLATION INSTRUCTIONS

- 40.** Next, align the shelf with the towel rack at the same height (if desired). Screw in place with 2x '4*40mm' screws. Be careful to stay clear of the light cable channel.



- 41.** Place the outside floor panel in front of the glass door, ensuring it's sitting level before securing it with 2x '4*40mm' screws.



- 42.** Piece together the heater fence using 4x '6*35mm' dome head screws



- 43.** Place the heater centered against the back panel, level against the lower support brace. Use your foot or a block to hold it level against the rear panel. Secure it in place with 4x '6*35mm' dome head screws.





- 44.** After unboxing the heater, attach the 'heater back panel' to the 'main heater unit'. Slide the back panel up into the rear side of the heater. This will allow you to get an idea of what height the back panel needs to be secured on the wall of the sauna.



- 45.** Place and hold the heater unit inside the heater fence, centered evenly. To find the vertical height, align the top edge of the back of the heater unit with the top of the fence.



Mark with a pencil where the 'heater back panel' naturally rests against the wall of the sauna.



- 46.** Remove the 'heater back panel' from the main heater unit. Hold it up against your reference mark you made with your pencil. Attach it to the wall using 6x '4*40mm' screws (three on each side) to secure the panel in place. These screws are provided with the sauna heater.



- 47.** Slide the main heater unit into place over the heater back panel, ensuring both grooves of the back panel are locked into the heater tight.

Then secure the heater into the back heater panel with 1x '3*25mm' screw (supplied with sauna heater).



4. INSTALLATION INSTRUCTIONS

- 48.** Bend out the small nodes of each vent using a flat head screw driver (or something similar).



- 49.** Place the vents into the pre-drilled holes around the sauna. Note the size of the vents - the floor stave vent will be slightly smaller.



- 50.** Next, place the two floor panels inside and fix with 2x '4*40mm' screws per panel using the pre-drilled holes.

Add back rests for the bench seats where you wish.

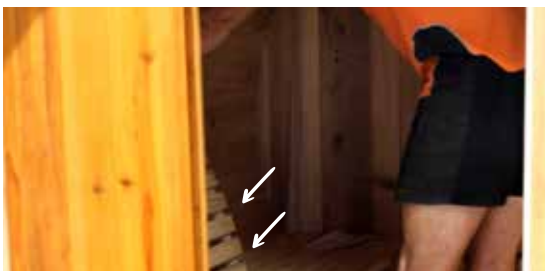

- 51.** Count to the 16th stave up from the bottom stave (bottom stave not counted) on each side of the sauna and pencil a mark for the 'triangular roof beam' to be secured. Fasten each beam with 5x '3*30mm' screws across the length of the sauna on each side. The triangular beam is should sit level with the top edge of the 16th stave.





52. Installing the bitumen roofing.

There are five different pieces that make up the bitumen roof by forming rows from different patterns. Familiarise yourself with the pieces and their corresponding letter in the guide. Follow the bitumen roofing pattern guide on the following page exactly until complete.

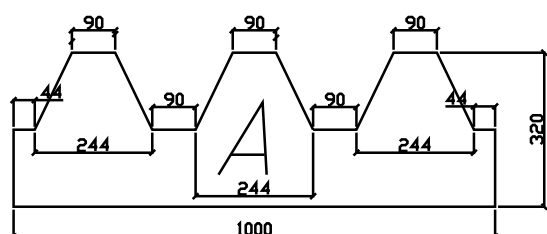

34pcs

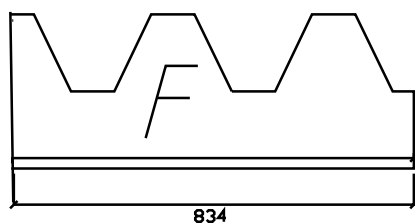

10pcs

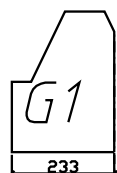

10pcs

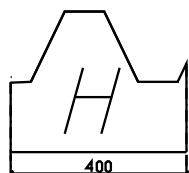

10pcs



2pcs

53. Use a caulking gun to apply waterproofing silicon between the last two rows and underneath the final pieces that cover the very top of the sauna to help prevent water seepage. Be generous with the amount of silicone used and use discretion on where to apply.



52. (Continued)

Tip: To help attach the bitumen to the sauna roof you can use a staple gun to hold each layer in place before screwing it down. This saves you having to hold it in place while drilling each screw in.



Fasten the bitumen to the sauna roof using '3*16mm' screws, one per hexagonal base edge. This will usually equate to 7 screws per row.



Turn to the following page for a full description of how each row should look, and what pieces each row is composed of.

54. Fix the final row down along the top edge with more '3*16mm' screws.



4. INSTALLATION INSTRUCTIONS

BITUMEN ROOFING PATTERN GUIDE

Right Side

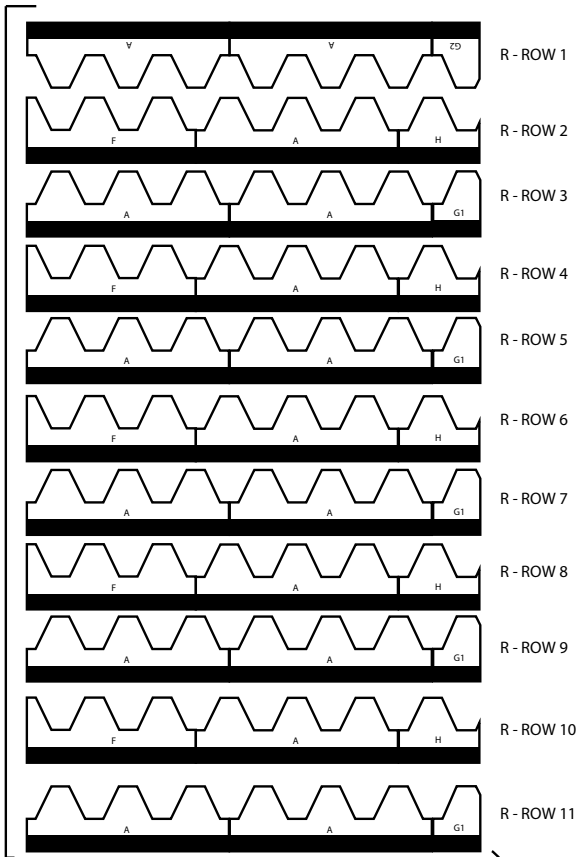

Overlap Row 11 onto Row 10 of Left side

Left Side

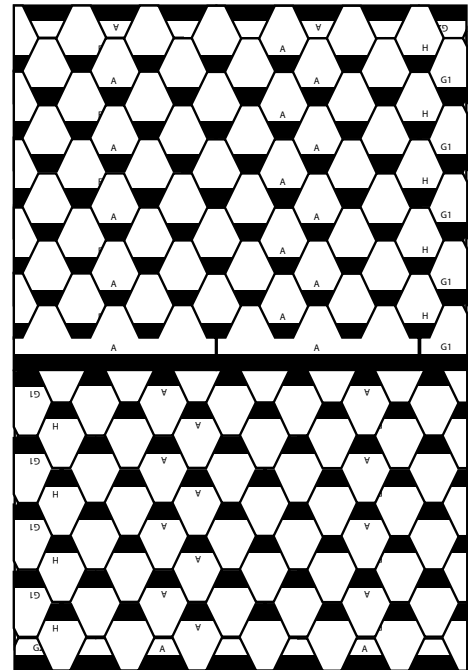
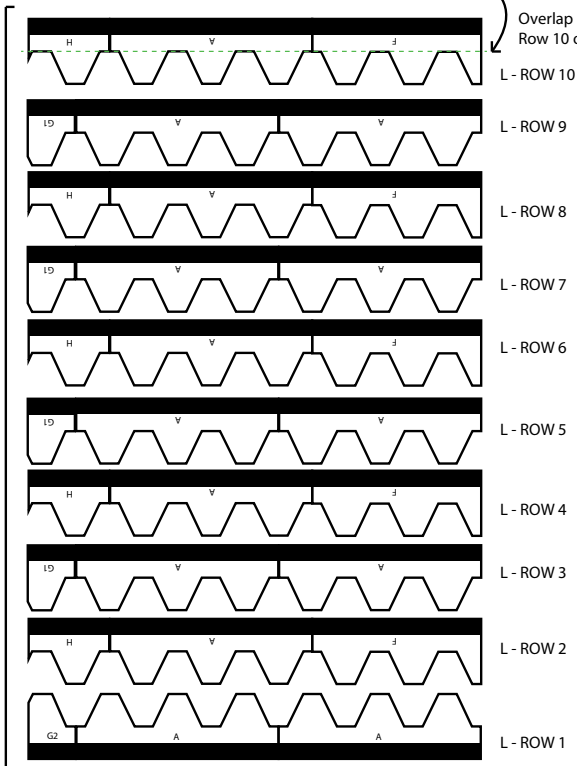

Left Side

Right Side



Start with the left side and complete the pattern until L-ROW 10. Then switch to the right side and complete the pattern until R-ROW 10. Silicon along the top edges (1 inch recess) of the ROW 10 pieces. Complete the bitumen by lapping R-ROW 11 over top of the gap and silicon to help with water proofing.

Demonstration of applying rows. Example below shows how L-ROW 1, L-ROW 2 and L-ROW 3 when applied.





- 54.** Finally, Add the capping to the front and back of the sauna using 4*40mm screws (2 per piece).



The capping is numbered accordingly. Capping piece #1 is the starting point, and should be attached first, to the centre of the barrel sauna. Note that the very centre of the top middle stave may not be true center, and measurements should be taken across the entire width of the sauna to find true center.



- 55.** Add the remaining accessories in your desired positions.

The magazine rack, sand-timer and hygrometre are simply installed anywhere inside the sauna with screws, except for over the top of the heater.



CONTACT INFORMATION

If you need assistance, please get in touch via phone or email.

service@alpinespas.co.nz 0800 99 33 88

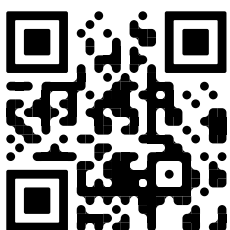

For a digital copy of this guide and also the outdoor sauna user guide visit:
<http://alpinespas.co.nz/support/>
OR
Scan this QR code with your smart phone



alpine**spas**™